



GOLUMEN®

EuroLight
▶ GRNLED Quality creates customer awareness and conscious customers create quality
LED LIGHT MANUFACTURER



📍 Add:4FL, Building B, Wanda Industrial Zone, Shiyan, Baoan District, Shenzhen
📍 Add2: 2nd Floor, No. 6, Fu'Qi Street, Tiebian Village, Henglan Town, Zhongshan, China
📞 +86 13570825764
✉ info@grnled.com / grnled01@gmail.com
📱 +86 13570825764 (whatsapp/ wechat ID)
🌐 <http://grnled.com>











2022
BROCHURE

By Greeniy Technology Co.,Limited

Greenrly Technology Co., Ltd(Shenzhen Gelvmei Technology Co., Ltd) built-in 2014, is one of the leading LED light manufacturers with 6S production management standard which is specialized in producing, designing, supplying, exporting, marketing-led lights.

- > One-stop supplier of indoor & outdoor led lights
- > OEM & SKD available
- > Top quality & Competitive price.
- > Customization for different requirements available
- > Fast delivery
- > Reliable warranty Policy.
- > CE RoHS approval for LED Lights
- > ISO9001:2015 Quality Management System.
- > Provide professional lighting testing reports IES.



	Solar Street Light	01-03
	LED Streetlight	04-09
	LED Floodlight	10-13
	LED High Bay	14-17
	LED Panel Light	18
	Magnetic/ Track Light	19-21
	Downlight/Spotlight	22-34
	LED Batten & LED Tube	35-36
	LED Linear Lighting	37
	Landscape lighting	38-43

GR-SSL-A Series



Feature

- Adjustable Joint (90°)
- LiFePO4 Li-Battery, 3.2V/12.8V System
- High brightness Led chips, 100-150lm/W output
- Radar Sensor, Photocell dusk to dawn.
- Mono Solar panel, high efficiency.



Order Model	Power Watt	Solar Panel Watt	Li-Battery Volt
GR-SSL-60WA	60W	18V 60W	12.8V 24AH
GR-SSL-80WA	80W	18V 80W	12.8V 30AH
GR-SSL-100WA	100W	18V 100W	12.8V 36AH

GR-SSL-B Series



Feature

- Top quality
- A grade LiFePO4 Li-Battery 12.8V System
- High brightness Led chips, 140-160lm/W output
- MPPT Solar controller, Mono Solar panel, high efficiency
- Pole installation as standard, other installation adapters can be customized



Order Model	Power Watt	Solar Panel Watt	Li-Battery Volt
GR-SSL-30WB	30W	18V 50W	12.8V 27AH
GR-SSL-40WB	40W	18V 65W	12.8V 28AH
GR-SSL-50WB	50W	18V 70W	12.8V 36AH
GR-SSL-60WB	60W	18V 80W	12.8V 42AH
GR-SSL-80WB	80W	18V 100W	12.8V 57AH
GR-SSL-100WB	100W	18V 130W	12.8V 63AH
GR-SSL-120WB	120W	18V 140W	12.8V 72AH

GR-SSL-F Series



Feature

- LiFePO4 Battery 12.8V
- Mono Solar panel, lifetime up 25years
- High brightness Led chips, 100-150lm/W output
- 3 different installation joints options



30W/40W



50W/60W/80W



100W/120W

Order Model	Power Watt	Solar Panel Watt	Li-Battery Volt
GR-SSL-30WF	30W	18V 50W	12.8V 24AH
GR-SSL-40WF	40W	18V 65W	12.8V 30AH
GR-SSL-50WF	50W	18V 70W	12.8V 36AH
GR-SSL-60WF	60W	18V 80W	12.8V 42AH
GR-SSL-80WF	80W	18V 100W	12.8V 48AH
GR-SSL-100WF	100W	18V 130W	12.8V 60AH
GR-SSL-120WF	120W	18V 150W	12.8V 66AH

GR-SSL-H Series

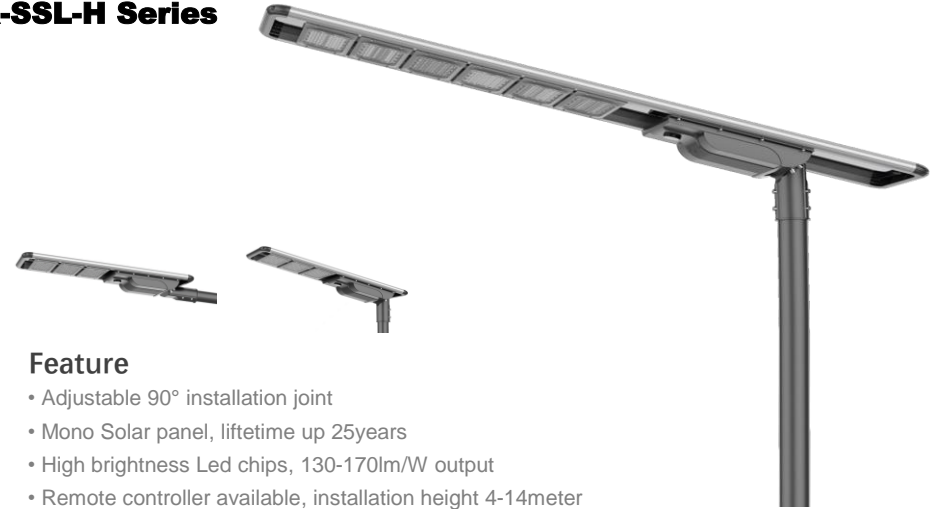

Feature

- Adjustable 90° installation joint
- Mono Solar panel, lifetime up 25years
- High brightness Led chips, 130-170lm/W output
- Remote controller available, installation height 4-14meter



40W



50W/60W



80W



100W/120W

Order Model	Power Watt	Solar Panel Watt	Li-Battery Volt
GR-SSL-40WH	40W	18V 50W	12.8V 24AH
GR-SSL-50WH	50W	18V 65W	12.8V 30AH
GR-SSL-60WH	60W	18V 70W	12.8V 36AH
GR-SSL-80WH	80W	18V 80W	12.8V 42AH
GR-SSL-100WH	100W	18V 100W	12.8V 48AH
GR-SSL-120WH	120W	18V 130W	12.8V 60AH

GR-ZC-A Series
All in Two

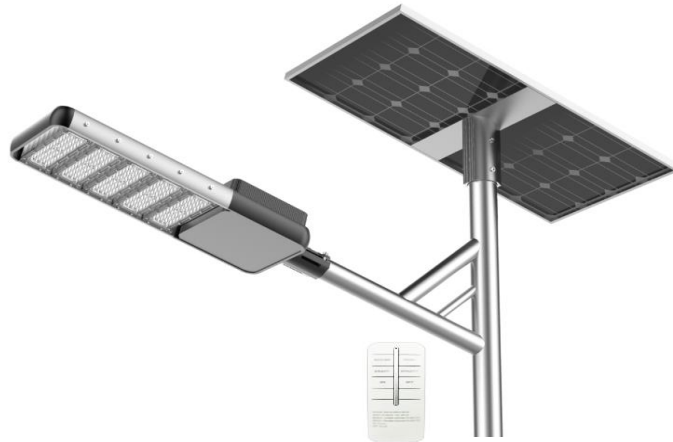

Feature

- Adjustable light module
- 12.8V Li-Battery be into street light body
- High brightness Led chips, 100-150lm/W output
- Working for pole height 5-14meter, Remote controller available

GR-ZC-B Series
All in Two

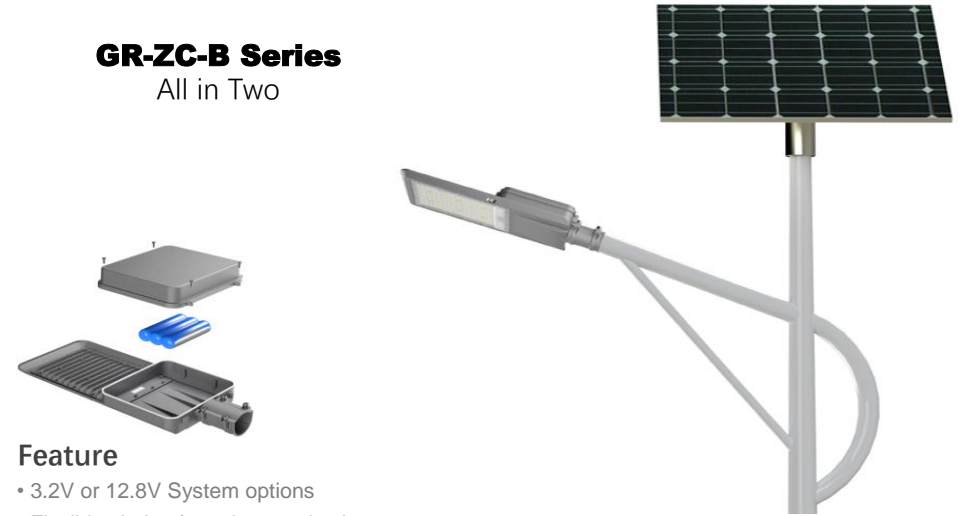

Feature

- 3.2V or 12.8V System options
- Flexible choice for solar panel volume.
- LED Chip QTY up to 300pcs Max, highest lumens with cheap price



30W/40W

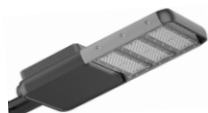

50W/60W

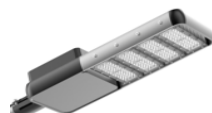

80W



100W/120W

Order Model	Power Watt	Solar Panel Watt	Li-Battery Volt
GR-ZC-30WA	30W	18V 40W	12.8V 18AH
GR-ZC-40WA	40W	18V 50W	12.8V 24AH
GR-ZC-50WA	50W	18V 65W	12.8V 30AH
GR-ZC-60WA	60W	18V 80W	12.8V 36AH
GR-ZC-80WA	80W	18V 100W	12.8V 42AH
GR-ZC-100WA	100W	18V 130W	12.8V 54AH
GR-ZC-120WA	120W	18V 170W	12.8V 60AH



50W/100W



120W



150W



200W



300W

Order Model	3030Chip QTY	Dimension mm	Lumens Lm	Install Height
GR-ZC-50B	50pcs	500*210*85	5000	4-6m
GR-ZC-60B	60pcs	500*210*85	6000	5-7m
GR-ZC-100B	100pcs	500*210*85	10000	7-8m
GR-ZC-120B	120pcs	550*225*90	11000	8-9m
GR-ZC-150B	150pcs	600*245*90	12000	10m
GR-ZC-200B	200pcs	660*267*95	13000	11m
GR-ZC-300B	300pcs	790*264*84	15000	12-14m

GR-SL-A Series



Feature

- Grey/black finished
- Philips SMD3030, 110-140lm/W Output
- DONE/PHILIPS/MEANWELL Driver, 2/3/5Years warranty
- Photocell / 0-10V/Triac Dimmable options. Lifetime up to 50000Hrs



Order Model	Power Watt	LED QTY PCS	PF	IP Grade	Install Diameter
GR-SL-30WA	30W	30pcs	>0.95	IP65	Φ40mm
GR-SL-50WA	50W	60pcs	>0.95	IP65	Φ50mm
GR-SL-100WA	100W	120pcs	>0.95	IP65	Φ60mm
GR-SL-150WA	150W	180pcs	>0.95	IP65	Φ60mm
GR-SL-180WA	180W	180pcs	>0.95	IP65	Φ60mm
GR-SL-200WA	200W	240pcs	>0.95	IP65	Φ60mm
GR-SL-250WA	250W	250pcs	>0.95	IP65	Φ60mm

GR-SL-B Series

Economy modular type

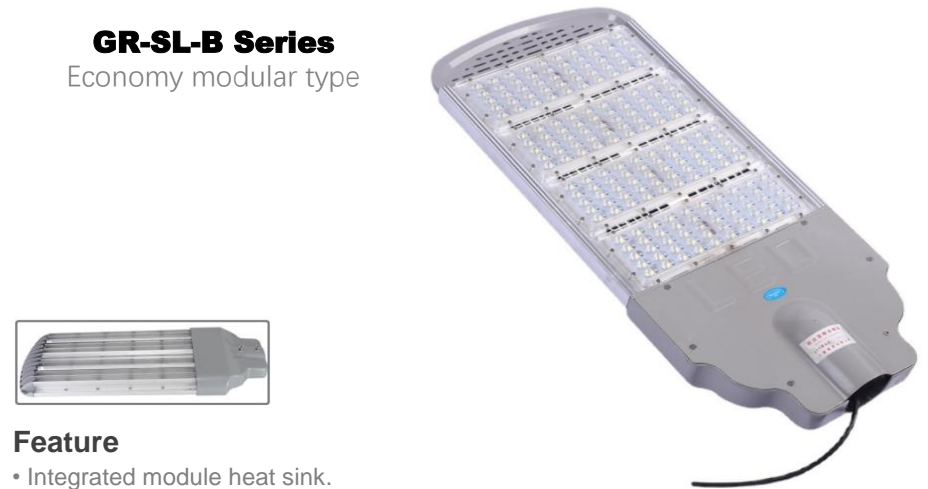

Feature

- Integrated module heat sink.
- Philips SMD3030, 110-150lm/W Output
- DONE/PHILIPS/MEANWELL Driver, 2/3/5Years warranty
- Photocell / 0-10V/Triac Dimmable options. 70*140° beam angle



Order Model	Power Watt	LED QTY PCS	PF	IP Grade	Install Diameter
GR-SL-100WB	100W	128pcs	>0.95	IP65	Φ60mm
GR-SL-150WB	150W	192pcs	>0.95	IP65	Φ60mm
GR-SL-200WB	200W	256pcs	>0.95	IP65	Φ60mm
GR-SL-250WB	250W	320pcs	>0.95	IP65	Φ60mm
GR-SL-300WB	300W	384pcs	>0.95	IP65	Φ60mm
GR-SL-400WB	400W	512pcs	>0.95	IP65	Φ60mm

GR-SL-C Series



Feature

- Grey/black finished
- Philips SMD3030 or COB, 100-110lm/W Output
- Photocell / 0-10V/Triac /DALI Dimmable options
- Isolated waterproof driver. 100-240VAC as standard, AC/DC12V 24V 48V available



Order Model	Power Watt	LED QTY PCS	PF	IP Grade	Install Diameter
GR-SL-50WC	50W	1pcs	>0.95	IP65	Φ50mm
GR-SL-100WC	100W	2pcs	>0.95	IP65	Φ60mm
GR-SL-150WC	150W	3pcs	>0.95	IP65	Φ60mm
GR-SL-200WC	200W	4pcs	>0.95	IP65	Φ60mm
GR-SL-250WC	250W	5pcs	>0.95	IP65	Φ60mm

GR-SL-E Series



Feature

- Grey/black finished
- Philips SMD3030, 120-140lm/W Output
- Photocell / 0-10V/Triac /DALI Dimmable / SPD(10-20KV) optional
- DONE /Meanwell/ PHILIPS Driver, 3/5Years warranty. DC12V 24V 48V available



Order Model	Power Watt	LED QTY PCS	PF	IP Grade	Install Diameter
GR-SL-100WE	100W	112pcs	>0.95	IP65	Φ60mm
GR-SL-150WE	150W	168pcs	>0.95	IP65	Φ60mm
GR-SL-200WE	200W	224pcs	>0.95	IP65	Φ60mm
GR-SL-250WE	250W	280pcs	>0.95	IP65	Φ60mm
GR-SL-300WE	300W	336pcs	>0.95	IP65	Φ60mm

GR-SL-H Series

Tool free

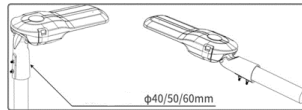

Feature

- Clip parts, free-tool design
- Adjustable installation joint, 40mm/50mm/60mm diameter option
- Meanwell/ Philips/ DONE driver top quality types, 3/5/7 Years warranty
- Photocell/ 0-10V dimmable/ Cut-off switch available, 60°/90°/120°/T2M/T3M/T4M beam angle

GR-SL-D Series

Economy



Feature

- Lens cover+Toughed glass cover.
- Philips/osram SMD LED Chips, 110-150lm/W output. 70°*140° beam angle
- Isolated driver /Meanwell/ Philips/ DONE, 2/3/5 Years warranty. 6-20KV Surge protection

50W



100W



150W



200W



Order Model	Power Watt	LED QTY PCS	PF	IP Grade	Install Diameter
GR-SL-50WH	50W	50pcs	>0.95	IP66	Φ50mm
GR-SL-100WH	100W	100pcs	>0.95	IP66	Φ60mm
GR-SL-150WH	150W	150pcs	>0.95	IP66	Φ60mm
GR-SL-200WH	200W	240pcs	>0.95	IP66	Φ60mm



Order Model	Power Watt	LED QTY PCS	PF	IP Grade	Install Diameter
GR-SL-100WD	100W	112pcs	>0.95	IP66	Φ60mm
GR-SL-120WD	120W	168pcs	>0.95	IP66	Φ60mm
GR-SL-150WD	150W	224pcs	>0.95	IP66	Φ60mm

GR-SL-K Series

Economy



Feature

- Slim design, economy solution
- Photocell/0-10V dimmable available.
- Bridgelux SMD LED Chips, 100-110lm/W output
- Isolated driver CE approval, stable quality, 2/3 Years warranty. 120° beam angle.

GR-SL-P Series

Tool- free

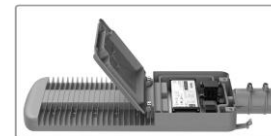

Feature

- Similar with PHILIPS Street light
- Clips design, Tool-free maintenance. Cut-off switch available
- Philips SMD 3030 LED Chips, 100-110lm/W output. Lens+ Glass cover
- Meanwell/ DONE/ PHILIPS DRIVER, 3/5/7 Years warranty. 70°*140° beam angle.



Order Model	Power Watt	LED QTY PCS	PF	IP Grade	Install Diameter
GR-SL-30WK	30W	30pcs	>0.95	IP65	Φ45mm
GR-SL-50WK	50W	50pcs	>0.95	IP65	Φ55mm
GR-SL-100WK	100W	100pcs	>0.95	IP65	Φ60mm
GR-SL-150WK	150W	150pcs	>0.95	IP65	Φ60mm
GR-SL-200WK	200W	200pcs	>0.95	IP65	Φ60mm



Order Model	Power Watt	LED QTY PCS	PF	IP Grade	Install Diameter
GR-SL-100WP	100W	112pcs	>0.95	IP66	Φ60mm
GR-SL-150WP	150W	168pcs	>0.95	IP66	Φ60mm
GR-SL-200WP	200W	224pcs	>0.95	IP66	Φ60mm
GR-SL-250WP	250W	280pcs	>0.95	IP66	Φ60mm

GR-SL-R Series

Adjustable



Feature

- Slim design, economy solution
- Adjustable installation joint, adjust 90°
- Bridgelux SMD LED Chips, 110-130lm/W output, 120° beam angle.
- Isolated driver CE approval, stable quality, 2/3 Years warranty. 4-6KV Surge protection



Order Model	Power Watt	LED QTY PCS	PF	IP Grade	Install Diameter
GR-SL-50WR	50W	50pcs	>0.95	IP66	Φ50mm
GR-SL-100WR	100W	100pcs	>0.95	IP66	Φ60mm
GR-SL-150WR	150W	150pcs	>0.95	IP66	Φ60mm
GR-SL-200WR	200W	200pcs	>0.95	IP66	Φ60mm

GR-SL-B-02 Series

Cheapest Modular



Feature

- Different installation part options
- Top quality in driver, and led chips, 120-170lm/W output
- Photocell /0-10V/DALI dimmable options, 6-20KV Surge protection, lifetime up to 100000hrs.



Order Model	Power Watt	LED QTY PCS	PF	IP Grade	Install Diameter
GR-SL-100WB-02	100W	112pcs	>0.95	IP66	Φ60mm
GR-SL-150WB-02	150W	168pcs	>0.95	IP66	Φ60mm
GR-SL-200WB-02	200W	224pcs	>0.95	IP66	Φ60mm

GR-SL-T Series

100W-400W

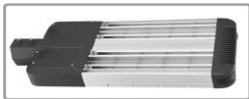

Feature

- Integrated module light design
- Philips SMD LED Chips, 110-150lm/W output,70°140° beam angle.
- Meanwell/DONE/PHILIPS/Isolated CE approval driver, 2/3/5/7Years warranty. 4-20KV

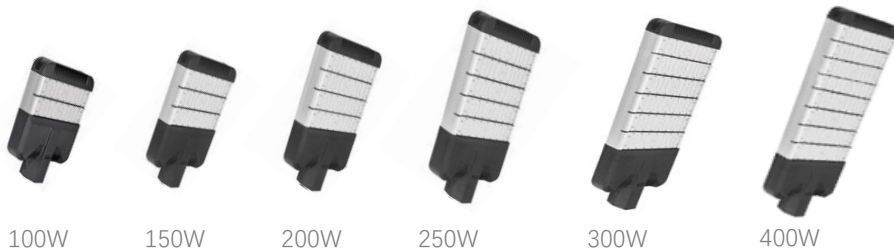

Order Model	Power Watt	LED QTY PCS	PF	IP Grade	Install Diameter
GR-SL-100WT	100W	112pcs	>0.95	IP66	Φ60mm
GR-SL-150WT	150W	168pcs	>0.95	IP66	Φ60mm
GR-SL-200WT	200W	224pcs	>0.95	IP66	Φ60mm
GR-SL-250WT	250W	280pcs	>0.95	IP66	Φ60mm
GR-SL-300WT	300W	336pcs	>0.95	IP66	Φ60mm
GR-SL-400WT	400W	447pcs	>0.95	IP66	Φ60mm

GR-SL-Y Series

Philips type



Feature

- Same as Philips street light in design
- Philips SMD LED Chips, 110-150lm/W output,70°140° beam angle.
- Meanwell/DONE/PHILIPS available, 3/5/7Years warranty. 6-20KV surge protection.



Order Model	Power Watt	LED QTY PCS	PF	IP Grade	Install Diameter
GR-SL-100WY	100W	144pcs	>0.95	IP66	Φ60mm
GR-SL-200WY	200W	240pcs	>0.95	IP66	Φ60mm
GR-SL-300WY	250/300W	288pcs	>0.95	IP66	Φ60mm
GR-SL-400WY	400W	480pcs	>0.95	IP66	Φ60mm

GR-FL-M Series

50W/Modular Flood Lights



Feature

- Fin aluminum heat sink or pur heat sink option.
- Philips SMD LED Chips, 110-160lm/W output,60°/90°/70°*140° beam angle.
- Meanwell/DONE/PHILIPS/Isolated CE approval driver, 3/5/7Years warranty. 6-10KV



Order Model	Power Watt	LED QTY PCS	PF	IP Grade	Voltage
GR-FL-50WM	50W	64pcs	>0.95	IP66	100-265V
GR-FL-100WM	100W	128pcs	>0.95	IP66	100-265V
GR-FL-150WM	150W	192pcs	>0.95	IP66	100-265V
GR-FL-200WM	200W	256pcs	>0.95	IP66	100-265V
GR-FL-250WM	250W	320pcs	>0.95	IP66	100-265V
GR-FL-300WM	300W	384pcs	>0.95	IP66	100-265V
GR-FL-400WM	400W	448pcs	>0.95	IP66	100-265V
GR-FL-500WM	500W	640pcs	>0.95	IP66	100-265V

GR-FL-E Series

50W/Modular Flood Lights



Feature

- 250W/modular for stadium, plaza as
- Philips SMD LED Chips, 110-150lm/W output,60°/90°/75°*150° beam angle.
- Meanwell/DONE/PHILIPS/Isolated CE approval driver, 3/5/7Years warranty. 6-10KV



Order Model	Power Watt	LED QTY PCS	PF	IP Grade	Voltage
GR-FL-100WE	100W	128pcs	>0.95	IP66	100-265V
GR-FL-150WE	150W	192pcs	>0.95	IP66	100-265V
GR-FL-200WE	200W	256pcs	>0.95	IP66	100-265V
GR-FL-250WE	250W	320pcs	>0.95	IP66	100-265V
GR-FL-300WE	300W	384pcs	>0.95	IP66	100-265V
GR-FL-400WE	400W	512pcs	>0.95	IP66	100-265V
GR-FL-500WE	500W	640pcs	>0.95	IP66	100-265V
GR-FL-600WE	600W	768pcs	>0.95	IP66	100-265V

GR-FL-K Series

250W/Modular Flood Lights



Feature

- 250W/modular for stadium, plaza as high mast.
- Philips SMD LED Chips, 110-160lm/W output, 15°/30°/45°/60°/90° beam angle.
- Meanwell/DONE/PHILIPS/Isolated CE approval driver, 3/5/7Years warranty. 6-10KV



500W



750W

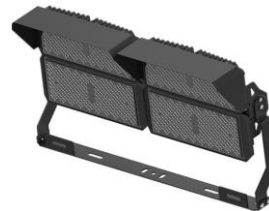

1000W

Order Model	Power Watt	LED QTY PCS	PF	IP Grade	Voltage
GR-FL-250WK	250W	336pcs	>0.95	IP66	100-265V
GR-FL-500WK	500W	672pcs	>0.95	IP66	100-265V
GR-FL-750WK	750W	1008pcs	>0.95	IP66	100-265V
GR-FL-1000WK	1000W	1334pcs	>0.95	IP66	100-265V
GR-FL-1500WK	1500W	2016pcs	>0.95	IP66	100-265V

GR-FL-G Series

250W/Module Stadium Floodlight



Feature

- Anti-glare cover optional.
- Philips SMD LED Chips, 130-160lm/W output, 2
- Meanwell/DONE/PHILIPS/Isolated CE approval driver, 3/5/7Years warranty. 6-10KV



2050W/500W



750W

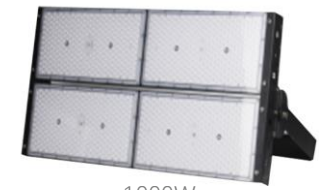

1000W

Order Model	Power Watt	LED QTY PCS	PF	IP Grade	Voltage
GR-FL-250WG	250W	343pcs	>0.95	IP66	100-265V
GR-FL-500WG	500W	686pcs	>0.95	IP66	100-265V
GR-FL-750WG	750W	1029pcs	>0.95	IP66	100-265V
GR-FL-1000WG	1000W	1372pcs	>0.95	IP66	100-265V
GR-FL-1500WG	1500W	2178pcs	>0.95	IP66	100-265V



GR-FL-L Series
IP66 85-265VAC PF>0.93

Order Model	Power Watt
GR-FL-30WL	30W
GR-FL-50WL	50W
GR-FL-100WL	100W
GR-FL-150WL	150W
GR-FL-200WL	200W



GR-FL-S Series
IP66 85-265VAC PF>0.93

Order Model	Power Watt
GR-FL-30WS	30W
GR-FL-50WS	50W
GR-FL-100WS	100W
GR-FL-150WS	150W
GR-FL-200WS	200W
GR-FL-300WS	300W



GR-FL-A Series (COB /SMD)
IP66 85-265VAC PF>0.93

Order Model	Power Watt
GR-FL-30WA	30W
GR-FL-50WA	50W
GR-FL-100WA	100W
GR-FL-150WA	150W
GR-FL-200WA	200W



GR-FL-A 02 Series
IP65 220-240VAC PF>0.93

Order Model	Power Watt
GR-FL-100WA-02	100W
GR-FL-150WA-02	150W
GR-FL-200WA-02	200W



GR-FL-A-03 Series (COB/ SMD)
IP66 85-265VAC PF>0.93

Order Model	Power Watt
GR-FL-50WA-03	50W
GR-FL-100WA-03	100W
GR-FL-150WA-03	150W
GR-FL-200WA-03	200W
GR-FL-300WA-03	300W
GR-FL-400WA-03	400W
GR-FL-500WA-03	500W



GR-FL-D Series (COB /SMD)
IP66 85-265VAC PF>0.93

Order Model	Power Watt
GR-FL-100WD	100W
GR-FL-150WD	150W
GR-FL-200WD	200W
GR-FL-300WD	300W
GR-FL-400WD	400W
GR-FL-500WD	500W
GR-FL-800WD	800W
GR-FL-1000WD	1000W

GR-FL-SP Series

Solar Flood light



Feature

- Top Solar Panel, high efficiency
- LiFepo4 Li-battery, very stable and long duration.
- Remote controller included, easy to do adjust the brightness and working time.
- Power display function. Easy to know the situation of power.

Order Model	Power Watt	LiFepo4 Battery	Solar Panel	IP Grade	Duration
GR-FL-50WSP	50W	3.2V 10AH	6V 12W	IP65	2raining day
GR-FL-120WSP	120W	3.2V15AH	6V 20W	IP65	2raining day
GR-FL-150WSP	150W	3.2V 20AH	6V 25W	IP65	2raining day
GR-FL-200WSP	200W	3.2V 25AH	6V 30W	IP65	2raining day

GR-FL-SL Series

Solar Flood light



Feature

- High quality Solar Panel, high efficiency
- LiFepo4 Li-battery, very stable and long duration.
- Remote controller included, easy to do adjust the brightness and working time.
- The glass cover and the battery are fixed with screws, which can be removed and replaced

Order Model	Power Watt	LiFepo4 Battery	Solar Panel	IP Grade	Duration
GR-FL-40WSL	40W	3.2V 5AH	6V 8W	IP65	2raining day
GR-FL-60WSL	60W	3.2V 10AH	6V 12W	IP65	2raining day
GR-FL-120WSL	120W	3.2V 15AH	6V 15W	IP65	2raining day
GR-FL-200WSL	200W	3.2V 20AH	6V 25W	IP65	2raining day
GR-FL-300WSL	300W	3.2V 25AH	6V 30W	IP65	2raining day
GR-FL-400WSL	400W	3.2V 30AH	6V 35W	IP65	2raining day
GR-FL-500WSL	500W	3.2V 40AH	6V 40W	IP65	2raining day
GR-FL-1000WSL	1000W	3.2V 50AH	6V 50W	IP65	2raining day

GR-HB-A Series

Classic



Feature

- Classic design-round
- Philips SMD LED Chips, 110-150lm/W output,90/120° beam angle.
- Meanwell/DONE/PHILIPS/Isolated CE approval driver, 2/3/5/7Years warranty.

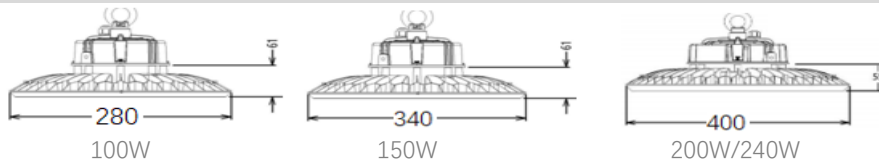

Order Model	Power Watt	LED QTY PCS	CRI	PF	IP Grade
GR-HB-100WA	100W	133pcs	>80	>0.95	IP65
GR-HB-150WA	150W	192pcs	>80	>0.95	IP65
GR-HB-200WA	200W	280pcs	>80	>0.95	IP65
GR-HB-240WA	240W	280pcs	>80	>0.95	IP65

GR-HB-D Series

0-10V/ DALI Dimmable available



Feature

- Copy philips in outlook.
- Philips SMD LED Chips, 110-150lm/W output,90° beam angle.
- Meanwell/DONE/PHILIPS/Isolated CE approval driver, 2/3/5/7Years warranty.

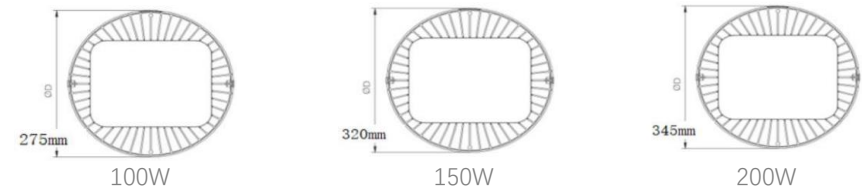

Order Model	Power Watt	LED QTY PCS	CRI	PF	IP Grade
GR-HB-100WD	100W	140pcs	>80	>0.95	IP65
GR-HB-150WD	150W	210pcs	>80	>0.95	IP65
GR-HB-200WD	200W	280pcs	>80	>0.95	IP65

GR-HB-E Series
Economy



Feature

- Economy type
- Bridgelux SMD LED Chips, 100-120lm/W output,90° beam angle.
- Isolated constant current led driver CE approval,high PF, 2/3Years warranty

GR-HB-F Series
Philips Type

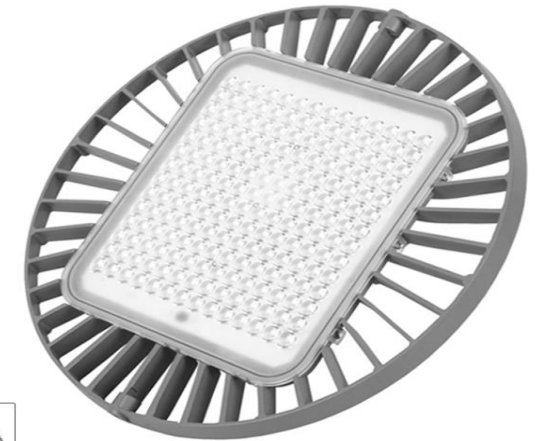

Feature

- PHILIPS Type,but cheaper price.
- Philips SMD LED Chips, 110-140lm/W output,90° beam angle.
- Meanwell/DONE/PHILIPS/Isolated CE approval driver, 2/3/5/7Years warranty.

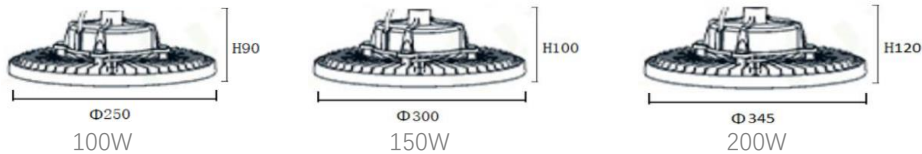

Order Model	Power Watt	CRI	Diameter	PF	IP Grade
GR-HB-100WE	100W	CRI80	Ø250	>0.95	IP65
GR-HB-150WE	150W	CRI80	Ø300	>0.95	IP65
GR-HB-200WE	200W	CRI80	Ø345	>0.95	IP65

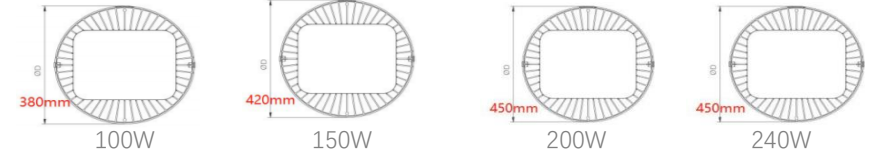

Order Model	Power Watt	LED QTY PCS	CRI	PF	IP Grade
GR-HB-100WF	100W	140pcs	>80	>0.95	IP65
GR-HB-150WF	150W	196pcs	>80	>0.95	IP65
GR-HB-200WF	200W	256pcs	>80	>0.95	IP65
GR-HB-240WF	240W	256pcs	>80	>0.95	IP65

GR-HB-S Series

Square High Bay Light

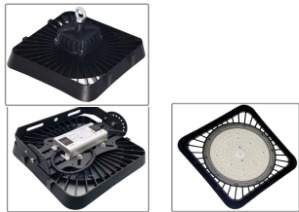

Feature

- Square design, it can be as street light with a extra joint.
- Philips SMD LED Chips, 110-120lm/W output,90° beam angle.
- Meanwell/Philips/Isolated constant current led driver CE approval, 2/3/5Years warranty,

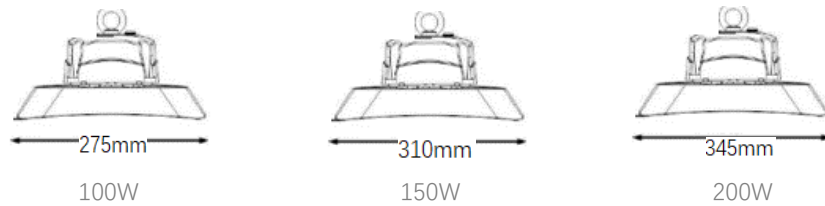

Order Model	Power Watt	LED QTY PCS	CRI	PF	IP Grade
GR-HB-100WS	100W	133pcs	>80	>0.95	IP65
GR-HB-150WS	150W	210pcs	>80	>0.95	IP65
GR-HB-200WS	200W	280pcs	>80	>0.95	IP65

GR-HB-B Series

160-190lm/W



Feature

- Highest lumens output.
- 60°/90°/120° beam angle..
- Top quality driver, 5 Years warranty.

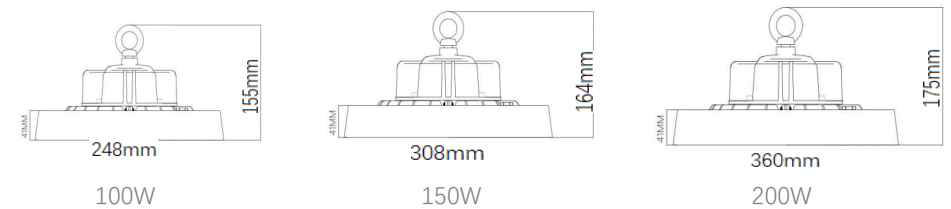

Order Model	Power Watt	Lumens lm	CRI	PF	IP Grade
GR-HB-100WB	100W	16000lm	>80	>0.95	IP65
GR-HB-150WB	150W	24000lm	>80	>0.95	IP65
GR-HB-200WB	200W	32000lm	>80	>0.95	IP65

GR-HB-M Series

Copper heat Channel



Feature

- Three different driver installation.
- Philips SMD LED Chips, 110-120lm/W output, 60/90°/120° beam angle.
- Meanwell/Philips/Isolated constant current led driver CE approval, 2/3/5Years warranty,

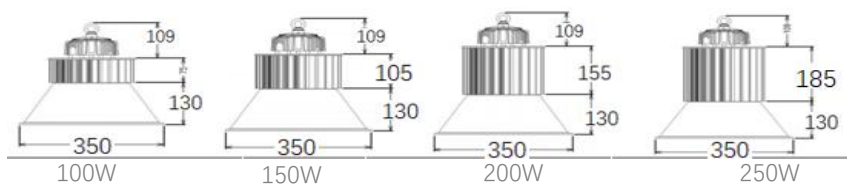

Order Model	Power Watt	LED QTY PCS	CRI	PF	IP Grade
GR-HB-100WM	100W	105pcs	>80	>0.95	IP65
GR-HB-150WM	150W	154pcs	>80	>0.95	IP65
GR-HB-200WM	200W	203pcs	>80	>0.95	IP65
GR-HB-250WM	250W	252pcs	>80	>0.95	IP65

GR-HB-L Series

Linear High Bay Lights



Feature

- 50W/Module, Suspension/Surface mounted options. 90° beam angle.
- Philips Chips, 110-130lm/W+Meanwell/Philips/DONE Driver, 2/3/5/7Years warranty/



Order Model	Power Watt	LED QTY PCS	Length mm	PF	IP Grade
GR-SL-50WL	50W	56pcs	353mm	>0.95	IP65
GR-SL-100WL	100W	112pcs	557mm	>0.95	IP65
GR-SL-150WL	150W	168pcs	823mm	>0.95	IP65
GR-SL-200WL	200W	224pcs	1089mm	>0.95	IP65
GR-SL-250WL	250W	280pcs	1355mm	>0.95	IP65
GR-SL-300WL	300W	336pcs	947mm	>0.95	IP65
GR-SL-400WL	400W	448pcs	1214mm	>0.95	IP65
GR-SL-500WL	500W	580pcs	1481mm	>0.95	IP65

GR-PL-D Series

Backlit type

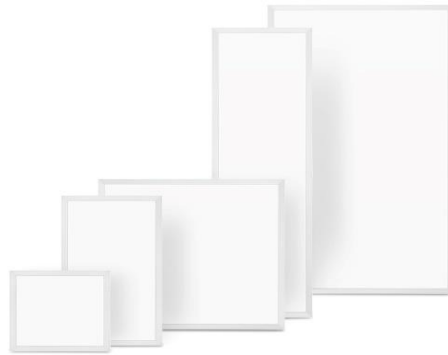

Feature

- Backlit type, without any yellow changing.
- Surface/ Suspension/ Clips/ Recessed installation options.
- Different size can be customized, such as 1200x200mm, 1200x1000mm, 900x300mm etc.
- Philips/Isolated driver CE approval, 2/3/5Years warranty. Epistar chips, 100-130lm/W output.



Suspension



Surface



Emergency backup

Order Model	Power Watt	Dimension mm	CRI	PF	IP Grade
GR-PL3030-18WD	18W	295*295	>80	>0.9	IP22
GR-PL6030-24WD	24W	595*295	>80	>0.95	IP22
GR-PL6060-40WD	40W	595*595	>80	>0.95	IP22
GR-PL12015-24WD	24W	1195*145	>80	>0.95	IP22
GR-PL12030-40WD	40W	1195*295	>80	>0.95	IP22
GR-PL12060-50WD	60W	1195*595	>80	>0.95	IP22
GR-PL12060-60WD	60W	1195*595	>80	>0.95	IP22

GR-PL Series

Edge-lit Slim type

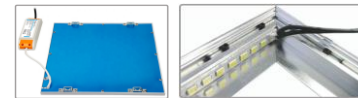

Feature

- Edge-lit design, super slim. Anti-UV LGP, avoiding yellow changing
- Surface/ Suspension/ Clips/ Recessed installation options.
- Philips/Isolated driver CE approval, 2/3/5Years warranty. Epistar chips, 100-130lm/W output.

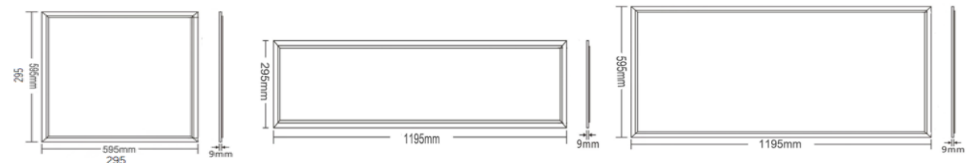

3030/6060

12030

12060

Order Model	Power Watt	Dimension mm	CRI	PF	IP Grade
GR-PL3030-18W	18W	295*295	>80	>0.9	IP22
GR-PL6060-40W	40W	595*595	>80	>0.95	IP22
GR-PL12030-40W	40W	1195*295	>80	>0.95	IP22
GR-PL12060-50W	50W	1195*595	>80	>0.95	IP22
GR-PL12060-60W	60W	1195*595	>80	>0.95	IP22



MAGNETIC TRACK LIGHTING SYSTEM

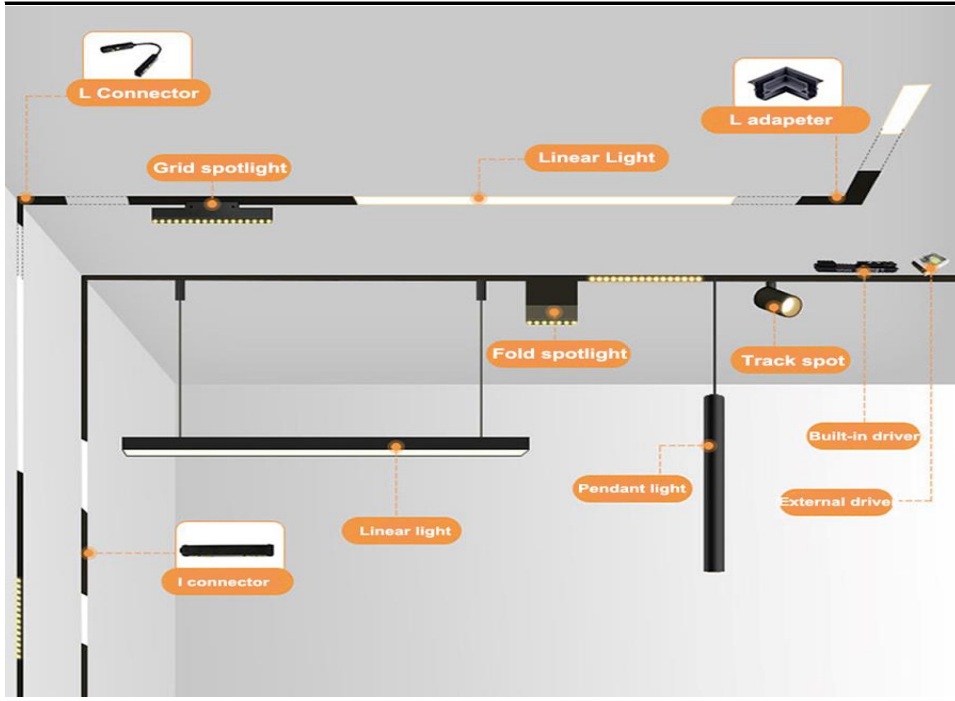

Magnetic track lighting is a new type of lighting with intelligent management system, it combines a variety of lighting fixtures that include floodlights, spotlights, wall washers. This system has an unique magnetic design, which makes the conductive strip on the track contact with the conductive strip on the lighting fixtures to supply power with firmly connection.

- DC48V Input / AC220V Input optional
 - 20MM/35MM Width Track optional
 - DALI Dimmable/2.4G WIFI, Bluetooth, Zigbee 3CCT+Dim solution+ Remote control
- Working with Google Home, Amazon Alexa smart speaker and TUYA APP.

Magnetic Track Linear Spotlights



Order Model	Power Watt	Dimension mm
GR-ML-6WGS	6W	L112*W22/35
GR-ML-12WGS	12W	L220*W22/35
GR-ML-18WGS	18W	L328*W22/35
GR-ML-24WGS	24W	L435*W22/35
GR-ML-30WGS	30W	L543*W22/35

Magnetic linear profile light



Order Model	Power Watt	Dimension mm
GR-ML-10WML	10W	L300*W22/35
GR-ML-20WML	20W	L600*W22/35
GR-ML-30WML	30W	L900*W22/35

Magnetic Fold Spotlights



Order Model	Power Watt	Dimension mm
GR-ML-6WFS	6W	L118*W22/35
GR-ML-12WFS	12W	L230*W22/35
GR-ML-18WFS	18W	L338*W20

Magnetic track spotlights



Order Model	Power Watt	Dimension mm
GR-ML-10WTL	10W	D50*100
GR-ML-15WTL	15W	D55*130
GR-ML-20WTL	20W	D60*135

Magnetic Pendant Lights



Order Model	Power Watt	Dimension mm
GR-ML-5WPL	5W	Φ30*H300mm



MAGNETIC TRACK LIGHTING SYSTEM

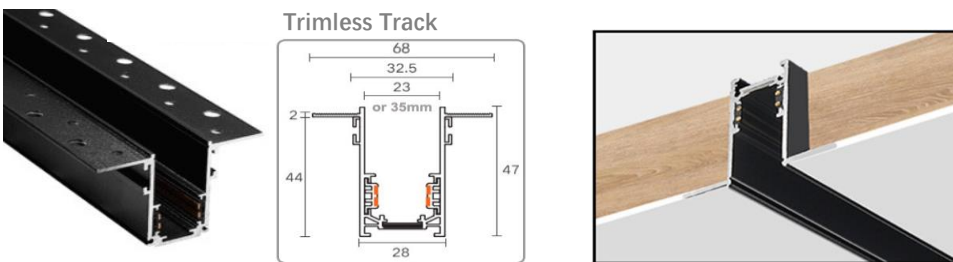
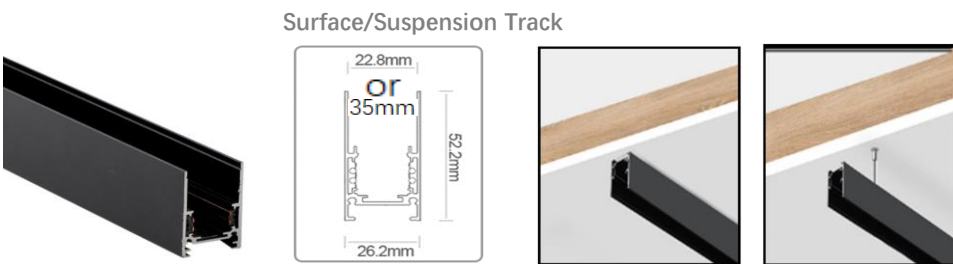
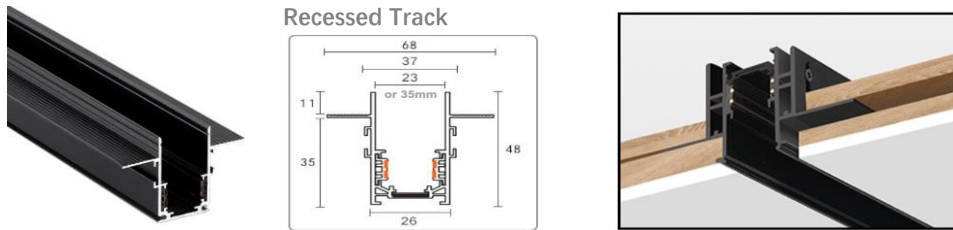
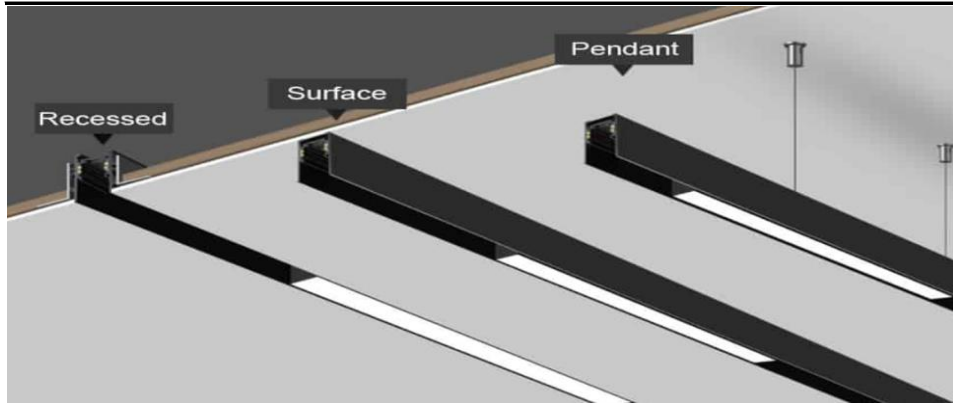

4 in 1 Magnetic track

One track can be compatible with surface, recessed, trimless, pendant installation

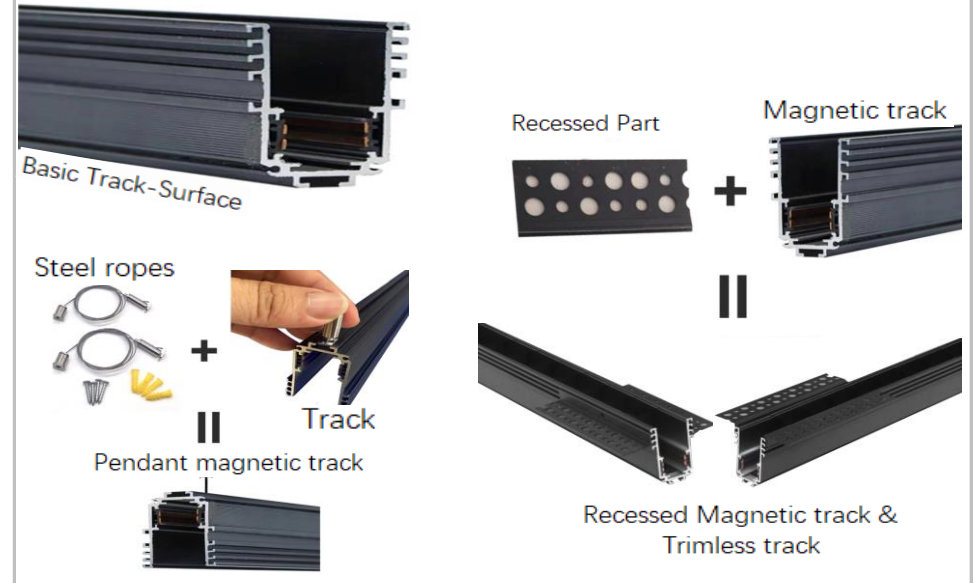



LED Track Lighting Series

2wires/3wires/4wires

N Series **Economy** Track Light



Order Model	Power Watt	CRI	IP Grade
GR-TL-10WN	10W±5%	>90	IP22
GR-TL-20WN	20W±5%	>90	IP22
GR-TL-30WN	30W±5%	>90	IP22

D Series **Adjustable Beam angle** 15°-60°



Order Model	Power Watt	CRI	IP Grade
GR-TL-10WD	10W±5%	>90	IP22
GR-TL-20WD	20W±5%	>90	IP22
GR-TL-30WD	30W±5%	>90	IP22

A Series Track Light



Order Model	Power Watt	CRI	IP Grade
GR-TL-10WA	10W	>90	IP22
GR-TL-15WA	15W	>90	IP22
GR-TL-20WA	18-20W	>90	IP22
GR-TL-30WA	28W	>90	IP22
GR-TL-35WA	35W	>90	IP22

B Series Commercial Track Light



Order Model	Power Watt	CRI	IP Grade
GR-TL-20WB	20W±5%	>90	IP22
GR-TL-30WB	30W±5%	>90	IP22

F Series Modern Track Light (Good price)



Order Model	Power Watt	CRI	IP Grade
GR-TL-20WF	20W±5%	>90	IP22
GR-TL-30WF	30W±5%	>90	IP22

Accessories for track lights



2 wires/3wires/ 4wires Track Rail: 1M/2M/3M

T Shape /Horizontal to L-type adapter

White/Black powder coated available

GR-DL-ZS Series

COB Smart downlight
Dual colors



24°
Feature

- Tuya Zigbee smart solution, working with TUYA APP (Phone control)
- Working with smart speaker like Google Home, Amazon Alexa etc.
- Mult-color, color changing from 3000K to 6500K.

GR-DL-ZN Series

SMD Smart downlight



100°
Feature

- Tuya Zigbee smart solution, working with TUYA APP (Phone control)
- Working with smart speaker like Google Home, Amazon Alexa etc.
- Mult-color, color changing from 3000K to 6500K.



Order Model	Power Watt	Dimension mm	Cut out mm	CRI	IP Grade
GR-DL-5WZS	5W	Φ63×H70	Ø55	>90	IP22
GR-DL-7WZS	7W	Ø85×H70	Ø75	>90	IP22
GR-DL-10WZS	10W	Ø85×H70	Ø75	>90	IP22
GR-DL-15WZS	15W	Ø110×H85	Ø95	>90	IP22



Order Model	Power Watt	Dimension mm	Cut out mm	CRI	IP Grade
GR-DL-7WZN	7W	ΦΦ85×50	Ø75	>90	IP22
GR-DL-9WZN	9W	Φ105×50	Ø95	>90	IP22
GR-DL-15WZN	15W	Φ130×65	Ø115	>90	IP22
GR-DL-18WZN	18W	Φ170×74	Ø170	>90	IP22

GR-DL-W Series

IP65 Waterproof
COB/ SMD Optional



Order Model	Power Watt	Dimension mm	Cut out mm	CRI	IP Grade
GR-DL-7WW	7W	Ø95*H45	Ø75	>90	IP65
GR-DL-12WW	12W	Ø115*H50	Ø95	>90	IP65
GR-DL-15WW	15W	Ø140*H55	Ø120	>90	IP65
GR-DL-20WW	20W	Ø165*H55	Ø145	>90	IP65
GR-DL-30WW	30W	Ø195*H55	Ø175	>90	IP65
GR-DL-40WW	40W	Ø230*H63	Ø205	>90	IP65

GR-DL-W-03 Series

IP54 Waterproof



Order Model	Power Watt	Dimension mm	Cut out mm	CRI	IP Grade
GR-DL-7WW-03	7W	Ø94	Ø75	>80	IP54
GR-DL-12WW-03	12W	Ø114	Ø110	>80	IP54
GR-DL-18WW-03	18-20W	Ø140	Ø120	>80	IP54
GR-DL-30WW-03	30W	Ø184	Ø160	>80	IP54

GR-DL-W-02 Series

IP65 Waterproof Spotlight



Order Model	Power Watt	Dimension mm	Cut out mm	CRI	IP Grade
GR-DL-7WW-02	7W	Ø72xH78	Ø60	>90	IP65
GR-DL-9WW-02	9W	Ø72xH78	Ø60	>90	IP65
GR-DL-12WW-02	12W	Ø92xH91	Ø75	>90	IP65
GR-DL-15WW-02	15W	Ø92xH91	Ø75	>90	IP65

GR-DL-G-03 Series

High Level-Hotel downlight



Order Model	Power Watt	Dimension mm	Cut out mm	CRI	IP Grade
GR-DL-10WG-03	10W	Ø90xH115	Ø75	>90	IP22
GR-DL-15WG-03	15W	Ø110xH115	Ø95	>90	IP22
GR-DL-20WG-03	20W	Ø110xH115	Ø95	>90	IP22
GR-DL-30WG-03	30W	Ø140xH160	Ø124	>90	IP22
GR-DL-40WG-03	40-50W	Ø160xH160	Ø145	>90	IP22

GR-DL-A Series

Deep downlight



100°

Feature

- Deep design, Anti-glare UGR<19
- Osram/Philips/Epistar SMD LED Chips, 100lm/W,100° beam angle.
- Philips/Osram/DONE/Isolated constant current led driver CE approval, 2/3/5Years warranty.



Gun Black reflector

Chrome/Silver reflector

White reflector

Order Model	Power Watt	Dimension mm	Cut out mm	CRI	IP Grade
GR-DL-7WA	7W	Ø79*H36	Ø65-70	>80	IP22
GR-DL-9WA	9W	Ø93*H45	Ø75-80	>80	IP22
GR-DL-12WA	12W	Ø112*H52	Ø95	>80	IP22
GR-DL-15WA	15W	Ø135*H60	Ø120	>80	IP22
GR-DL-18WA	18W	Ø162*H72	Ø140-145	>80	IP22
GR-DL-24WA	24W	Ø192*H83	Ø170-175	>80	IP22
GR-DL-30WA	30W	Ø225*H97	Ø205	>80	IP22
GR-DL-36WA	36W	Ø225*H97	Ø205	>80	IP22

GR-DL-B Series

Anti-glare downlight



60°



Feature

- Deep design, Anti-glare UGR<17
- Osram/Philips/Epistar SMD LED Chips, 100lm/W,60° beam angle.
- Philips/Osram/DONE/Isolated led driver CE approval, 2/3/5Years warranty.
- Triac/0-10V/DALI dimmable, Emergency kits, Zigbee Smart control can be as options.

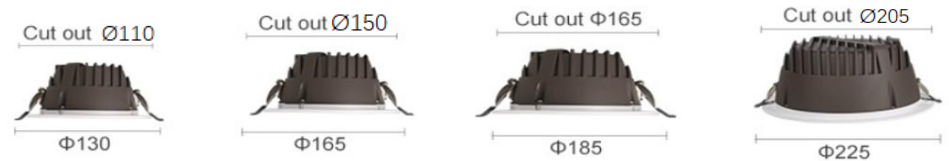

Order Model	Power Watt	Dimension mm	Cut out mm	CRI	IP Grade
GR-DL-12WB	12W	Ø130*H60	Ø110	>80	IP22
GR-DL-15WB	15W	Ø165*H65	Ø150	>80	IP22
GR-DL-18WB	18W	Ø185*H80	Ø165	>80	IP22
GR-DL-24WB	24W	Ø225*H90	Ø205	>80	IP22
GR-DL-30WB	30W	Ø225*H90	Ø205	>80	IP22

GR-DL-D Series

Economy 2.5-9INCH
COB/SMD Type



SMD



COB

Feature

- COB/SMD Type optional.
- CREE/CITIZEN/Bridgelux COBChips, CRI90,100lm/W.
- Philips/Osram/DONE/Isolated constant current led driver CE approval, 2/3/5Years warranty.

GR-DL-N Series

4inch- 10inch
COB/SMD optional



120°

Feature

- Die-cast aluminum, good quality.
- CREE/CITIZEN/Bridgelux COBChips, CRI90,100lm/W. SDCM<5
- Philips/Osram/DONE, 2/3/5Years warranty. Triac/0-10V/DALI/ Emergency backup options.



SMD



COB

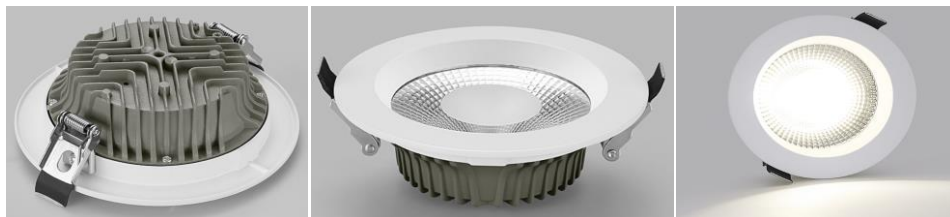

Order Model	Power Watt	Dimension mm	Cut out mm	CRI	IP Grade
GR-DL-5WD	5W	Ø100*H43	Ø75	>90	IP22
GR-DL-7WD	7W	Ø106*H46	Ø90	>90	IP22
GR-DL-9WD	9W	Ø106*H46	Ø90	>90	IP22
GR-DL-12WD	12W	Ø115*H46	Ø95	>90	IP22
GR-DL-15WD	15W	Ø140*H55	Ø120	>90	IP22
GR-DL-18WD	18W	Ø180*H60	Ø160	>90	IP22
GR-DL-24WD	24W	Ø190*H60	Ø170	>90	IP22
GR-DL-30WD	30W	Ø220*H62	Ø205	>90	IP22
GR-DL-30WD	30W	Ø250*H62	Ø230-240	>90	IP22



4inch/5inch/6inch/8inch



9inch/10inch

Order Model	Power Watt	Dimension mm	Cut out mm	CRI	Inch
GR-DL-15WN	15W	Ø145*H62	Ø125	>90	4inch
GR-DL-20WN	20W	Ø160*H62	Ø145	>90	5inch
GR-DL-30WN	30W	Ø190*H62	Ø175	>90	6inch
GR-DL-40WN	40W	Ø230*H75	Ø205	>90	8inch
GR-DL-50WN	50W	Ø230*H105	Ø205	>90	8inch
GR-DL-40WN	40W	Ø250*H75	Ø220-235	>90	9inch
GR-DL-40WN	40W	Ø300*H110	Ø240-280	>90	10inch

GR-DL-F Series

Trimless LED Downlight

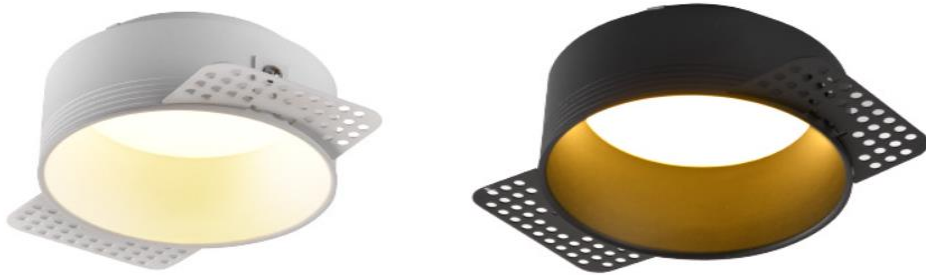

Feature

- Trimless installation
- Osram/Philips/Bridgelux SMD Chips, CRI80,100lm/W.
- Philips/Osram/DONE/Isolated constant current led driver CE approval, 3/5Years warranty.

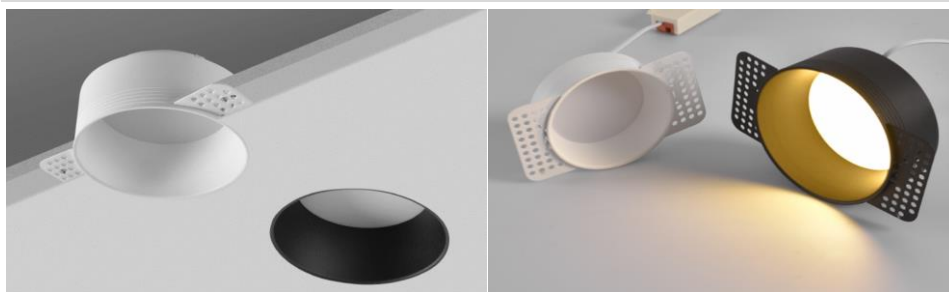

Order Model	Power Watt	Lumens lm	Cut out mm	CRI	IP Grade
GR-DL-7WF	7W	600-700lm	Ø80	>80	IP20
GR-DL-9WF	9W	810lm	Ø100	>80	IP20
GR-DL-12WF	12W	1000lm	Ø100	>80	IP20
GR-DL-15WF	15W	1350lm	Ø125	>80	IP20
GR-DL-20WF	18-24W	1800lm	Ø150	>80	IP20

GR-DL-E Series

Classic SMD Downlight



Feature

- Triac/0-10V/DALI/ Emergency backup options.
- Osram/Philips/Bridgelux SMD Chips, CRI80,100lm/W.
- Philips/Osram/DONE/Isolated constant current led driver CE approval, 2/3/5Years warranty.



Order Model	Power Watt	Dimension mm	Cut out mm	CRI	IP Grade
GR-DL-7WE	7W	Ø106*H46	Ø90	>80	IP22
GR-DL-9WE	9W	Ø115*H46	Ø95	>80	IP22
GR-DL-12WE	12W	Ø140*H55	Ø120	>80	IP22
GR-DL-15WE	15W	Ø180*H60	Ø160	>80	IP22
GR-DL-18WE	18W	Ø190*H60	Ø170	>80	IP22
GR-DL-24WE	24W	Ø230*H70	Ø205	>80	IP22
GR-DL-30WE	30W	Ø230*H70	Ø205	>80	IP22

GR-DL-J Series

Curve frame downlight



Feature

- Triac/0-10V/DALI/ Emergency backup options.
- CREE/CITIZEN/Bridgelux COBChips, CRI90,100lm/W. SDCM<5
- Philips/Osram/DONE/Isolated constant current led driver CE approval, 2/3/5Years warranty.

GR-DL-M Series

Anti glare COB Downlight



Feature

- Deep reflector, Anti glare.
- CREE/CITIZEN/Bridgelux COBChips, CRI90,100lm/W. SDCM<5
- Philips/Osram/DONE/Isolated constant current led driver CE approval, 2/3/5Years warranty.



Order Model	Power Watt	Dimension mm	Cut out mm	CRI	IP Grade
GR-DL-9WJ	9W	Ø90*H50	Ø75	>90	IP22
GR-DL-12WJ	12W	Ø120*H50	Ø105	>90	IP22
GR-DL-18WJ	18W-20W	Ø148*H85	Ø125	>90	IP22
GR-DL-30WJ	25W-30W	Ø200*H105	Ø185	>90	IP22
GR-DL-40WJ	30W-40W	Ø230*H110	Ø205	>90	IP22



Order Model	Power Watt	Dimension mm	Cut out mm	CRI	IP Grade
GR-DL-10WM	10W	Ø110*H75	Ø95	>90	IP22
GR-DL-15WM	15W	Ø130*H96	Ø115	>90	IP22
GR-DL-20WM	20W	Ø158*H106	Ø140	>90	IP22
GR-DL-30WM	25W-30W	Ø182*H118	Ø160	>90	IP22
GR-DL-40WM	30W-40W	Ø230*H130	Ø205	>90	IP22

GR-DL-R Series

Anti glare commercial
SMD /COB Optional



Feature

- Deep desgin, Anti glare, low glare.
- CREE/CITIZEN/Bridgelux COBChips, CRI90,100lm/W. SDCM<5
- Philips/Osram/DONE, 2/3/5Years warranty. Triac/0-10V/DALI/ Emergency backup options.



Order Model	Power Watt	Dimension mm	Cut out mm	CRI	IP Grade
GR-DL-7WR	7-9W	Ø100*H75	Ø75	>90	IP22
GR-DL-12WR	12W	Ø120*H75	Ø95	>90	IP22
GR-DL-15WR	15W	Ø145*H80	Ø120	>90	IP22
GR-DL-20WR	20W	Ø170*H80	Ø155	>90	IP22
GR-DL-24WR	20-24W	Ø190*H85	Ø175	>90	IP22
GR-DL-35WR	30-35W	Ø230*H95	Ø205	>90	IP22

GR-DL-S Series

Top grade/COB



Feature

- Deep reflector, different color options.
- CREE/CITIZEN/Bridgelux COBChips, CRI90,100lm/W. SDCM<5
- Philips/Osram/DONE, 2/3/5Years warranty. Triac/0-10V/DALI/ Emergency backup options.

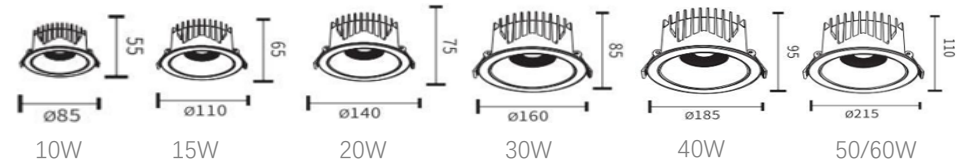

Order Model	Power Watt	Dimension mm	Cut out mm	CRI	IP Grade
GR-DL-10WS	10W	Ø85*H55	Ø75	>90	IP22
GR-DL-15WS	15W	Ø110*H65	Ø95	>90	IP22
GR-DL-20WS	20W	Ø140*H75	Ø120	>90	IP22
GR-DL-30WS	30W	Ø160*H85	Ø145	>90	IP22
GR-DL-40WS	40W	Ø185*H95	Ø170	>90	IP22
GR-DL-50WS	50W	Ø215*H110	Ø195	>90	IP22
GR-DL-60WS	60W	Ø215*H110	Ø195	>90	IP22



Adjustable Deep spotlight

Model	Power	Size(mm)	Outcut	IP Grade
GR-DL-7WG	7W	Ø85*H60	Ø75	IP22
GR-DL-10WG	10W	Ø85*H78	Ø75	IP22
GR-DL-15WG	15W	Ø104*H100	Ø95	IP22
GR-DL-20WG	20W	Ø130*H120	Ø115	IP22
GR-DL-24WG	25W-30w	Ø130*H120	Ø115	IP22



Adjustable Trimless downlight

Model	Power	Size(mm)	Outcut	CRI
GR-DL-5WY	5W	Ø110*H77	Ø65	>90
GR-DL-7WY	7W	Ø147*H82	Ø85	>90
GR-DL-10WY	10W	Ø147*H82	Ø85	>90
GR-DL-15WY	15W	Ø175*H107	Ø105	>90



Adjustable Square spotlight

Model	Power	Size(mm)	Outcut	CRI
GR-DL-5WV	5W	W68*H70	W55*L55	>90
GR-DL-7WV	7W	W90*H90	W75*L75	>90
GR-DL-10WV	10W	W90*H90	W75*L75	>90
GR-DL-15WV	15W	W107*H107	W95*L95	>90



Trimless Square downlight

Model	Power	Size(mm)	Outcut	CRI
GR-DL-5WG-01	5W	Ø130*H77	Ø80	>90
GR-DL-7WG-01	7W	Ø130*H82	Ø80	>90
GR-DL-10WG-01	10W	Ø130*H102	Ø80	>90
GR-DL-15WG-01	15W	Ø130*H120	Ø80	>90



L Series Put out Gimbal Downlight

Model	Power	Size(mm)	Outcut	CRI
GR-DL-7WG-02	7W	Ø90*H100	Ø75	>90
GR-DL-12WG-02	12W	Ø110*H135	Ø95	>90
GR-DL-18WG-02	18W	Ø130*H135	Ø120	>90
GR-DL-30WG-02	30W	Ø165*H170	Ø145	>90



IP44 Recessed COB Downlight

Model	Power	Size(mm)	Cut Out(mm)	IP Grade
GR-DL-12WH	12W	Ø110*72	φ90-95	IP44
GR-DL-20WH	18-20W	Ø140*82	φ120-125	IP44
GR-DL-24WH	24W	Ø160*92	φ140-145	IP44
GR-DL-30WH	30W	Ø180*102	φ140-145	IP44
GR-DL-40WH	40W	Ø210*112	φ195-200	IP44

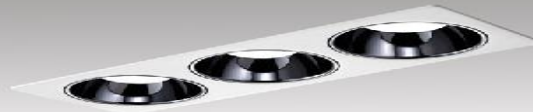

Grid downlight fixture



Grid downlight(One/Double/Triple)

Model	Power	Cutout(mm)	CRI	Model	Power	Cutout(mm)	CRI
GR-DLG-10WE*1	10W	L105*W105	>90	GR-DLG-15WE*3	15W*3	L355*W125	>90
GR-DLG-10WE*2	10W*2	L205*W105	>90	GR-DLG-20WE*1	20W	L160*W160	>90
GR-DLG-10WE*3	10W*3	L305*W105	>90	GR-DLG-20WE*2	20W*2	L310*W160	>90
GR-DLG-15WE*1	15W	L125*W125	>90	GR-DLG-20WE*3	20W*3	L460*W160	>90
GR-DLG-15WE*2	15W*2	L245*W125	>90				



Pull out downlight(One/Double)

Model	Power	Cutout(mm)	CRI
GR-DLG-7WF*1	7W	φ75	>90
GR-DLG-7WF*2	7W*2	L155*W75	>90
GR-DLG-15WF*1	15W	φ95	>90
GR-DLG-15WF*2	15W*2	L190*W95	>90
GR-DLG-20WF*1	20W	φ115	>90
GR-DLG-20WF*2	20W*2	L230*W120	>90



Grille downlight(One/Double)

Model	Power	Cutout(mm)	CRI
GR-DLG-9WP*1	9W	L75*W75	>90
GR-DLG-9WP*2	9W*2	L155*W75	>90
GR-DLG-15WP*1	15W	L95*W95	>90
GR-DLG-15WP*2	15W*2	L195*W95	>90
GR-DLG-25WP*1	25W	L125*W125	>90
GR-DLG-25WP*2	25W*2	L230*W125	>90



Pull out downlight

Model	Power	Cutout(mm)	CRI
GR-DLG-10WH*1	10W	L75*W75	>90
GR-DLG-10WH*2	10W*2	L155*W75	>90
GR-DLG-10WH*3	10W*3	L225*W75	>90
GR-DLG-10WH*4	10W*4	L155*W155	>90



Deep grid downlight

Model	Power	Cutout(mm)	CRI
GR-DLG-9WA*1	9W	L75*W75	>90
GR-DLG-9WA*2	9W*2	L162*W75	>90
GR-DLG-9WA*3	9W*3	L245*W75	>90
GR-DLG-9WA*4	9W*4	L162*W162	>90

GR-DL-SH Series

Surface Grid downlight



Order Model	Power Watt	Dimension mm	Lifetime	CRI	IP Grade
GR-DL-10WSH	10W	L105*W105	>50000Hrs	>90	IP22
GR-DL-10WSH*2	20W	L205*W105	>50000Hrs	>90	IP22
GR-DL-10WSH*4	40W	L225*W225	>50000Hrs	>90	IP22
GR-DL-12WSH	12W	L105*W105	>50000Hrs	>90	IP22
GR-DL-12WSH*2	24W	L205*W105	>50000Hrs	>90	IP22
GR-DL-12WSH*4	48W	L225*W225	>50000Hrs	>90	IP22

GR-DL-SM Series

Single/Double Surface grid



Order Model	Power Watt	Dimension mm	Lifetime	CRI	IP Grade
GR-DL-10WSM	10W	L100*W100	>50000Hrs	>90	IP22
GR-DL-10WSM*2	20W	W100*L200	>50000Hrs	>90	IP22
GR-DL-15WSM	15W	L115*L115	>50000Hrs	>90	IP22
GR-DL-15WSM*2	30W	W115*L230	>50000Hrs	>90	IP22
GR-DL-20WSM	20W	L115*L115	>50000Hrs	>90	IP22
GR-DL-20WSM*2	40W	W115*L230	>50000Hrs	>90	IP22

GR-DL-I Series

Fold Surface Spotlight



Order Model	Power Watt	Diameter mm	Cutout mm	CRI	Base
GR-DL-10WI	10W	φ70*100	>50000Hrs	>90	IP20
GR-DL-15WI	15W	φ90*110	>50000Hrs	>90	IP20
GR-DL-20WI	20W	φ110*115	>50000Hrs	>90	IP20
GR-DL-25WI	25W	φ110*130	>50000Hrs	>90	IP20

GR-DL-CL Series

Recessed long cylinder light



Order Model	Power Watt	Dimension mm
GR-DL-5WCL100	5W	Ø67*L100
GR-DL-5WCL200	5W	Ø67*L200
GR-DL-5WCL300	5W	Ø67*L300

GR-DL-GU Series

GU10 Base downlight



GU10 to be 5W 7W only

Module to be 9W-15W
Dia:88mm, Outcut:75mm

GR-FM-A Series

Surface mounted



Feature

- Surface mounted/Suspension available.
- Aluminum body, white/Black finished. Different color for reflectors options.
- CREE/CITIZEN/Bridgelux COBChips, 100lm/W. SDCM<5. Top quality driver, 50000Hrs lifetime

GR-FM-B Series

Classic Surface cylinder



Feature

- Surface mounted/Suspension available.
- Metal body+ Aluminum heat sink, white/black finished.
- CREE/CITIZEN/Bridgelux COBChips, CRI90, 100lm/W. SDCM<5
- Philips/Osram/DONE, 2/3/5Years warranty. Triac/0-10V/DALI/ Emergency backup options.



Order Model	Power Watt	Dimension mm	PF	CRI	IP Grade
GR-FM-7WA	7W	Ø55*H110	>0.6	>90	IP22
GR-FM-12WA	12W	Ø75*H130	>0.6	>90	IP22
GR-FM-15WA	15W	Ø95*H140	>0.6	>90	IP22
GR-FM-20WA	20W	Ø115*H140	>0.9	>90	IP22

Order Model	Power Watt	Dimension mm	PF	CRI	IP Grade
GR-FM-10WB	10W	Ø108*H128	>0.6	>90	IP22
GR-FM-15WB	15W	Ø140*H155	>0.6	>90	IP22
GR-FM-20WB	20W	Ø170*H178	>0.9	>90	IP22
GR-FM-30WB	30W	Ø190*H190	>0.9	>90	IP22
GR-FM-40WB	40W	Ø220*H225	>0.9	>90	IP22
GR-FM-50WB	50W	Ø230*H250	>0.9	>90	IP22
GR-FM-60WB	60W	Ø230*H250	>0.9	>90	IP22
GR-FM-70WB	70W	Ø230*H250	>0.9	>90	IP22

GR-FM-F Series

IP65 Waterproof



Feature

- Waterproof rubber to be IP65 protection.
- Aluminum body, white/Black finished. With surface parts.
- CREE/CITIZEN/Bridgelux COBChips, 100lm/W. SDCM<5. Top quality driver, 50000Hrs lifetime

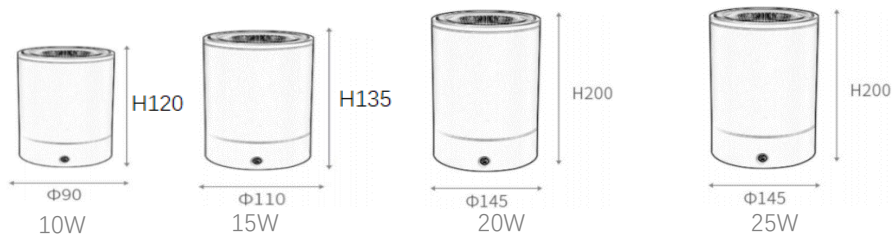

Order Model	Power Watt	Dimension mm	PF	CRI	IP Grade
GR-FM-10WF	10W	Ø90*H120	>0.6	>90	IP65
GR-FM-15WF	15W	Ø110*H135	>0.6	>90	IP65
GR-FM-20WF	20W	Ø145*H200	>0.9	>90	IP65
GR-FM-25WF	25W	Ø145*H200	>0.9	>90	IP65

GR-DL-Z01 Series

Fold surface cylinder



Feature

- Fold surface design, can be as spotlight.
- Aluminum body, white/Black finished. With surface parts.
- CREE/CITIZEN/Bridgelux COBChips, 100lm/W. SDCM<5. Top quality driver, 50000Hrs lifetime

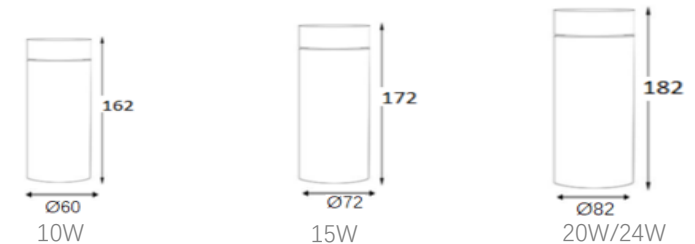

Order Model	Power Watt	Dimension mm	PF	CRI	IP Grade
GR-FM-10WF	10W	Ø60*H162	>0.6	>90	IP22
GR-FM-15WF	15W	Ø72*H172	>0.6	>90	IP22
GR-FM-20WF	20W	Ø82*H182	>0.9	>90	IP22
GR-FM-24WF	24W	Ø82*H182	>0.9	>90	IP22

GR-CD-E Series

Slim & IP65 Waterproof



Feature

- Slim design, only 60mm height. IP65 waterproof.
- Plastic bottom+ABS frame, different frame colors(white/black/silver/gold) options.
- Epistar SMD LED Chips,90-100lm/W output. Constant current driver, 2/3Years warranty.



12W

18W

24W

32W

Order Model	Power Watt	Dimension mm	PF	CRI	IP Grade
GR-CD-12WE	12W	Ø240*H60	>0.6	>80	IP65
GR-CD-18WE	18W	Ø300*H60	>0.6	>80	IP65
GR-CD-24WE	24W	Ø400*H60	>0.9	>80	IP65
GR-CD-32WE	32W	Ø480*H60	>0.9	>80	IP65

GR-CD-H Series

Emergency kits available



Feature

- Classic design with IP65 protection
- Plastic bottom+ABS frame. Big space to be with Emergency kits
- Epistar SMD LED Chips,90-100lm/W output. Constant current driver, 2/3Years warranty.

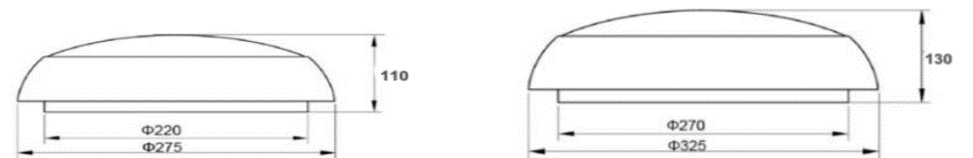

12W

18W/24W

Order Model	Power Watt	Dimension mm	PF	CRI	IP Grade
GR-CD-12WH	12W	Ø275*H110	>0.6	>80	IP65
GR-CD-18WH	18W	Ø325*H130	>0.9	>80	IP65



LED Tri-proof Batten

Order Model	Power Watt	Remark
GR-TPS-2F9WB	9W	600mm
GR-TPS-4F18WB	18W	1200mm
GR-TPS-5F22WB	22W	1500mm
GR-TPD-2F18WB	9W*2	600mm
GR-TPD-4F36WB	18W*2	1200mm
GR-TPD-5F44WB	22W*2	1500mm

Order Model	Power Watt	Remark
GR-TPS-2F9WA	9W	1pcs*2FT
GR-TPS-4F18WA	18W	1pcs*4FT
GR-TPS-5F22WA	22W	1pcs*5FT
GR-TPD-2F18WA	9W*2	2pcs*2FT
GR-TPD-4F36WA	18W*2	2pcs*4FT
GR-TPD-5F44WA	22W*2	2pcs*5FT

Dust-proof Batten



Order Model	Power Watt	Length mm	IP Grade
GR-DF-600A/B	18W	600	IP44
GR-DF-1200A/B	36W	1200	IP44
GR-DF-1500A/B	44W	1500	IP44



Order Model	Power Watt	Length mm	IP Grade
GR-TPP-600	18W	600	IP65
GR-TPP-1200	36W	1200	IP65
GR-TPP-1500	44W	1500	IP65



TUBE LED T8 Series

Order Model	Power Watt	Length mm
GR-T8600-9W	9W	590mm
GR-T8900-13W	13W	890mm
GR-T81200-18W	18W	1198mm
GR-T81500-22W	22W	1498mm
GR-T81800-26W	26W	1778mm
GR-T82400-36W	36W	2378mm

Single/Double end input option

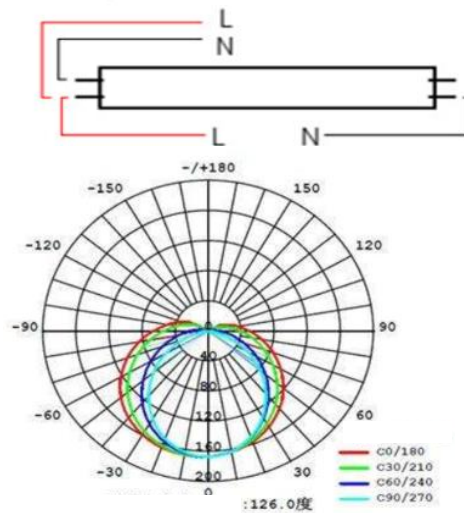

T5 LED Batten

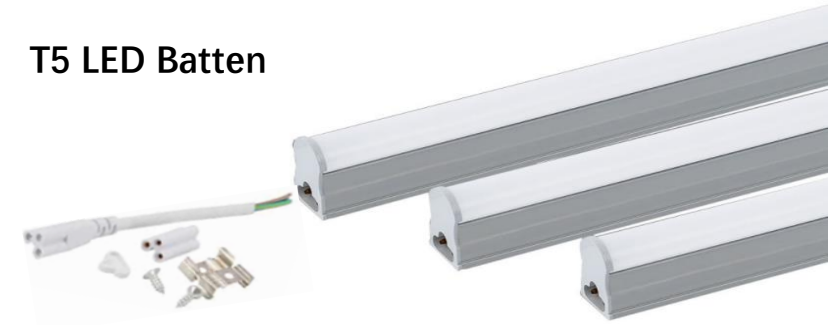

Order Model	Power Watt	Length mm	CRI	IP Grade
GR-T5600-9WB	9W	600mm	>80	IP22
GR-T5900-13WB	13W	900mm	>80	IP22
GR-T51200-18WB	18W	1200mm	>80	IP22
GR-T51500-22WB	22W	1500mm	>80	IP22



Waterproof T8 LED

Order Model	Power Watt	Length mm	CRI	IP Grade
GR-T8600-9WF	9W	600mm	>80	IP65
GR-T81200-18W	18W	1200mm	>80	IP65
GR-T81500-22W	22W	1500mm	>80	IP65

GR-LS5075 Series

Pendant/ Surface Linear lights
2400mm 600mm can be option

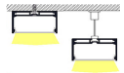

Order Model	Power Watt	Dimension mm	CRI	IP Grade
GR-LS5075-1200	36W	L1185*W50*H75	>80	IP22
GR-LS5075-1500	48W	L1485*W50*H75	>80	IP22
GR-LS5050-1200	36W	L1180*W50*H50	>80	IP22
GR-LS5050-1500	48W	L1485*W50*H50	>80	IP22

GR-LS5035/6535 Series

Recessed Linear Light

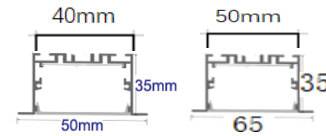

Order Model	Power Watt	Length mm	Outcut mm	CRI	IP Grade
GR-LS5035-1200	36W	1200	W40*H65	>80	IP22
GR-LS5035-1500	48W	1500	W40*H65	>80	IP22
GR-LS5035-2400	60W	2400	W40*H65	>80	IP22
GR-LS6535-1200	36W	1200	W52*H65	>80	IP22
GR-LS6535-1500	48W	1500	W52*H65	>80	IP22
GR-LS6535-2400	72W	2400	W52*H65	>80	IP22

Recessed Linear Spotlights



Order Model	Power Watt	Outcut mm
GR-LS-5*2W	9W	L1185*W50*H75
GR-LS-10*2W	18W	L1485*W50*H75
GR-LS-15*2W	27W	L2390*W50*H75

Other Type Profile Options

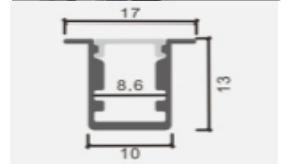
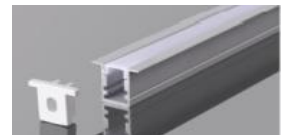
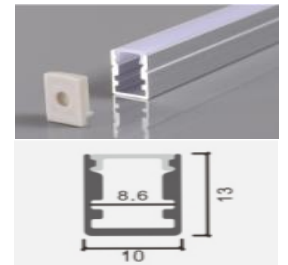
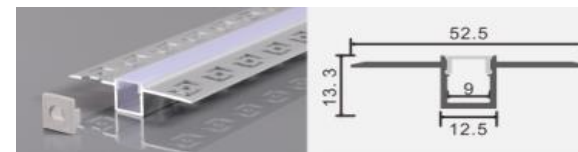

Combined pendant lamp

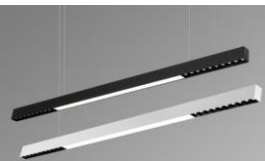

Order Model	Power Watt	Dimension mm
GR-LS6633-36W	36W	L1065*W33*H66



Order Model	Power Watt	Dimension mm
GR-LS60-1200	36W	L1200*D60
GR-LS60-1500	45W	L1500*D60

GR-BL-A Series

Modern Bollard light

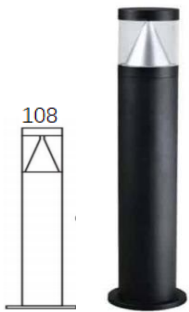

Order Model	Power Watt	Dimension mm	IP Grade
GR-BL-600A	7W	Ø108*H600	IP65
GR-BL-800A	7W	Ø108*H600	IP65
GR-BL-1000A	7W/9w	Ø108*H1000	IP65

White/Black Housing options.

GR-BL-E Series

Bollard light

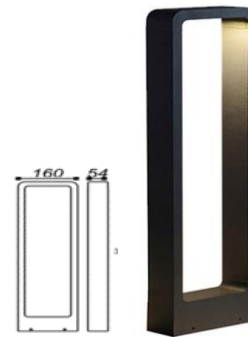

Order Model	Power Watt	Dimension mm	IP Grade
GR-BL-300E	7W	Ø108*H300	IP65
GR-BL-600E	7W	Ø108*H600	IP65
GR-BL-800E	7W	Ø108*H800	IP65

The other height like 1000mm 1200mm can be customized

GR-BL-B Series

Bollard light



Order Model	Power Watt	Dimension mm	IP Grade
GR-BL-300B	7W	Ø108*H300	IP65
GR-BL-600B	9W	Ø108*H600	IP65
GR-BL-800B	9W	Ø108*H800	IP65

The other height like 1000mm 1200mm can be customized
It is ok to be 2.5m/3m/4m height with 165mm Diameter

GR-BL-D Series

Square Bollard light



Order Model	Power Watt	Dimension mm	IP Grade
GR-BL-600D	9W	Ø120*H600	IP65
GR-BL-800D	9W	Ø120*H800	IP65
GR-BL-1000D	9W	Ø120*H1000	IP65

The other height like 1200mm 1500mm can be customized
It is ok to be 2.5m/3m/3.5m/4m height with 200mm width

GR-BL-F Series

Bollard light

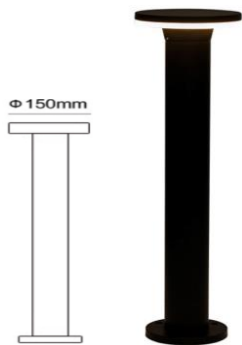

GR-BL-300F	9W
GR-BL-600F	9W
GR-BL-800F	9W
IP65 100-240VAC	



GR-BL-F Series

Garden Bollard light

3/5W 100-240VAC
Base/ Spike Installation
IP65

GR-BL-M Series

Pillar Lights

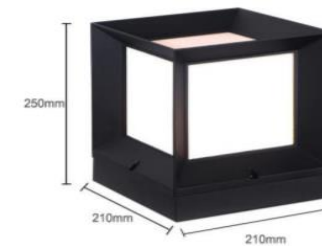

Size:210*210*H250
E27 Base or SMD Type
5W/7W IP65

GR-GL-A Series

Inground Light



Order Model	Power Watt	Outcut mm	IP Grade
GR-GL-3WA	3W	Ø105*H85	IP67
GR-GL-6WA	6W	Ø110*H95	IP67
GR-GL-9WA/12WA	9W/12W	Ø150*H100	IP67
GR-GL-18WA	18W	Ø195*H100	IP67
GR-GL-24WA	24W	Ø210*H100	IP67
GR-GL-36WA	36W	Ø240*H100	IP67
GR-GL-48WA	26W	Ø290*H100	IP67

GR-GL-F Series

Square Inground uplighter



Order Model	Power Watt	Outcut mm	IP Grade
GR-GL-3WF	3W	LW95*H80	IP67
GR-GL-5WF	5W	LW115*H80	IP67
GR-GL-9WF	9W	LW140*H85	IP67
GR-GL-12WF	12W	LW155*H85	IP67
GR-GL-18WF	18W	LW195*H90	IP67

GR-GL-H Series

COB Inground Light



Order Model	Power Watt	Outcut mm	IP Grade
GR-GL-10WH	10W	Ø145*H95	IP67
GR-GL-20WH	20W	Ø170*H100	IP67
GR-GL-30WH	30W	Ø210*H100	IP67
GR-GL-50WH	50W	Ø240*H100	IP67

GR-GL-L Series

Linear Inground uplighter



Order Model	Power Watt	Outcut mm	IP Grade
GR-GL-3WL	3W	L195*W75	IP67
GR-GL-6WL	6W	L290*W85	IP67
GR-GL-9WL	9W	L290*W85	IP67
GR-GL-12WL	12W	L490*W85	IP67
GR-GL-24WL	24W	L990*W85	IP67
GR-GL-36WL	36W	L990*85	IP67

GR-GL-B Series

Small Inground Light

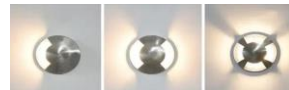

Order Model	Power Watt	Outcut mm	IP Grade
GR-GL-1WB42	1W	Ø38	IP67
GR-GL-1WB52	1W	Ø48	IP67
GR-GL-1WB62	1W	Ø58	IP67

GR-GL-R Series

Adjustable Inground uplighter



Order Model	Power Watt	Outcut mm	IP Grade
GR-GL-3WR	3W	Ø110*H150	IP67
GR-GL-5WR	5W	Ø140*H205	IP67
GR-GL-9WR	9W	Ø170*H251	IP67
GR-GL-12WR	12W	Ø170*H251	IP67
GR-GL-18WR	18W	Ø220*H300	IP67

GR-SP-A Series

Spike/ Surface Spot Light



Order Model	Power Watt	Outcut mm	IP Grade
GR-SP-5WA (COB)	5W	Ø105*H85	IP66
GR-SP-6WA	6W	Ø110*H95	IP66
GR-SP-9WA	9W	Ø150*H100	IP66
GR-SP-12WA	12W	Ø195*H100	IP66
GR-SP-18WA	18W	Ø210*H100	IP66
GR-SP-24WA	24W	Ø240*H100	IP66
GR-SP-36WA	26W	Ø290*H100	IP66

GR-SP-H Series

Top Quality Uplighter



Order Model	Power Watt	Voltage	IP Grade
GR-SP-10WH	7W-10W	100-240V	IP66
GR-SP-15WH	12W-15W	100-240V	IP66
GR-SP-20WH	18W-20W	100-240V	IP66
GR-SP-30WH	25W-30W	100-240V	IP66

GR-SP-M Series

Narrow Beam Spot light



Order Model	Power Watt	Beam angle	IP Grade
GR-SP-10WM	10W	5°	IP67

GR-SP-Q Series

Commercial outdoor Spot light



Order Model	Power Watt	Diameter mm	Voltage V	CRI	IP Grade
GR-SP-10WQ	10W	Ø80	100-240V	>90	IP66
GR-SP-20WQ	20W	Ø100	100-240V	>90	IP66
GR-SP-30WQ	30W	Ø125	100-240V	>90	IP66

GR-SP-T Series

Rectangle Spot light



Order Model	Power Watt	Size mm	CRI	IP Grade
GR-SP-12WT	12W	L190*W160*H290	>80	IP66
GR-SP-18WT	18W	L190*W160*H290	>80	IP66
GR-SP-24WT	24W	L320*W160*H290	>80	IP66
GR-SP-36WT	36W	L320*W160*H290	>80	IP66
GR-SP-48WT	48W	L320*W160*H290	>80	IP66

GR-BD-A Series

Up down Wall light



Order Model	Power Watt	Dimension mm	IP Grade
GR-BD-2x7WA	2x7W	Ø105*H85	IP66
GR-BD-2x10WA	2x10W	Ø110*H95	IP66
GR-BD-2x15WA	2x15W	Ø150*H100	IP66
GR-BD-2x20WA	2x20W	Ø195*H100	IP66

GR-BD-F Series

COB/ GU10 Outdoor Wall Light



Order Model	Power Watt	Dimension mm	IP Grade
GR-BD-5WF-Round	5W	L80*W70*H80	IP65
GR-BD-2x5WF-Round	2x5W	85*W70*H150	IP65
GR-BD-5WF-Square	5W	L80*W70*H80	IP65
GR-BD-2x5WF-Square	2x5W	85*W70*H150	IP65

GR-BD-B Series

Square Wall Light (Single or double heads)



Order Model	Power Watt	Dimension mm	IP Grade
GR-BD-2x7WB	2x7W	Ø105*H85	IP66
GR-BD-2x10WB	2x10W	Ø110*H95	IP66
GR-BD-2x15WB	2x15W	Ø150*H100	IP66
GR-BD-2x20WB	2x20W	Ø195*H100	IP66
GR-BD-2x15WB	2x15W	Ø150*H100	IP66
GR-BD-2x20WB	2x20W	Ø195*H100	IP66

GR-BD-L Series

Recessed Outdoor Wall Light



Order Model	Power Watt	Cut out mm	IP Grade
GR-BD-3WL-N(narrow)	3W	L170*W35*H50	IP65
GR-BD-3WL-N(narrow)	3W	L75*W35*H50	IP65
GR-BD-3WL-R(Rectangle)	3W	L205*W55*H60	IP65
GR-BD-3WL-S(square)	3W	L80*W80*H51	IP65

GR-BD-E Series

Adjustable beam angle

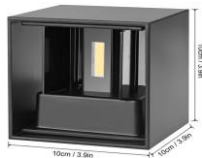

Order Model	Power Watt	Size mm	CRI	IP Grade
GR-BD-2x3WE	2x3W	L100*W100*H100	>80	IP66

GR-BD-R Series

Wall Mounted(SMD/GU10 Type option)



Order Model	Power Watt	Size mm	CRI	IP Grade
GR-BD-12WR	12W	Ø220*H65	>80	IP65
GR-BD-18WR	18W	Ø275*H85	>80	IP65

GR-WW-A Series

220V Wall Washer Light



Order Model	Power Watt	Length mm	Voltage	CRI	IP Grade
GR-WW-9WA	9W	500	100-240V	>80	IP66
GR-WW-12WA	12W	500	100-240V	>80	IP66
GR-WW-18WA	18W	1000	100-240V	>80	IP66
GR-WW-24WA	24W	1000	100-240V	>80	IP66
GR-WW-36WA	36W	1000	100-240V	>80	IP66

GR-WW-B Series

DC12/24V Wall Washer light



Order Model	Power Watt	Length mm	Voltage	CRI	IP Grade
GR-WW-18WB	18W	1000	DC12/24V	>80	IP66
GR-WW-24WB	24W	1000	DC12/24V	>80	IP66
GR-WW-36WB	36W	1000	DC12/24V	>80	IP66
GR-WW-48WB	48W	1000	DC12/24V	>80	IP66

GR-UL-A Series

DC12/24V Underwater Light



Order Model	Power Watt	Diameter mm	Voltage	CRI	IP Grade
GR-UL-6WA	6W	Ø120*H140	DC24V	>80	IP68
GR-UL-9WA	9W	Ø145*H180	DC24V	>80	IP68
GR-UL-12WA	12W	Ø145*H180	DC24V	>80	IP68
GR-UL-18WA	18W	Ø175*H210	DC24V	>80	IP68
GR-UL-24WA	24W	Ø210*H230	DC24V	>80	IP68

GR-UL-B Series

DC12/24V Recessed Underwater light



Order Model	Power Watt	Cut out mm	Voltage	CRI	IP Grade
GR-UL-6WB	6W	Ø115*H95	DC24V	>80	IP68
GR-UL-9WB	9W	Ø145*H115	DC24V	>80	IP68
GR-UL-12WB	12W	Ø155*H100	DC24V	>80	IP68
GR-UL-18WB	18W	Ø195*H115	DC24V	>80	IP68
GR-UL-24WB	24W	Ø195*H115	DC24V	>80	IP68



GR-TYS Series Solar Garden Lights
 Power:20W/25W/30W/50W
 Duration:3-5raining days
 Remark:Hyrid solution available.



GR-TYF Series Garden lights

GR-TYD Series Modern Garden Lights		Garden Pole Lights 38*38*56cm	
Dimension:	Height	Model	Power
150mm/160mm/200mm* option	2.5m/3m/3.5m/4m	GR-TY-30/50/70W	30W/50W/70W
Aluminum body/	20W/30W 40W/50W	GR-TY-100/150W	100W/120W/150W

- Feature:
- 1.Different pattern can be customized.
 - 2.Different height can be option 2.5m/3m/3.5m/4m
 - 3.Aluminum body,anti-corrosion.
 - 4.Power 20W 30W 50W optional.